

SULLIVANS

Item No. 38434

# Quilter's Table

## Instructions

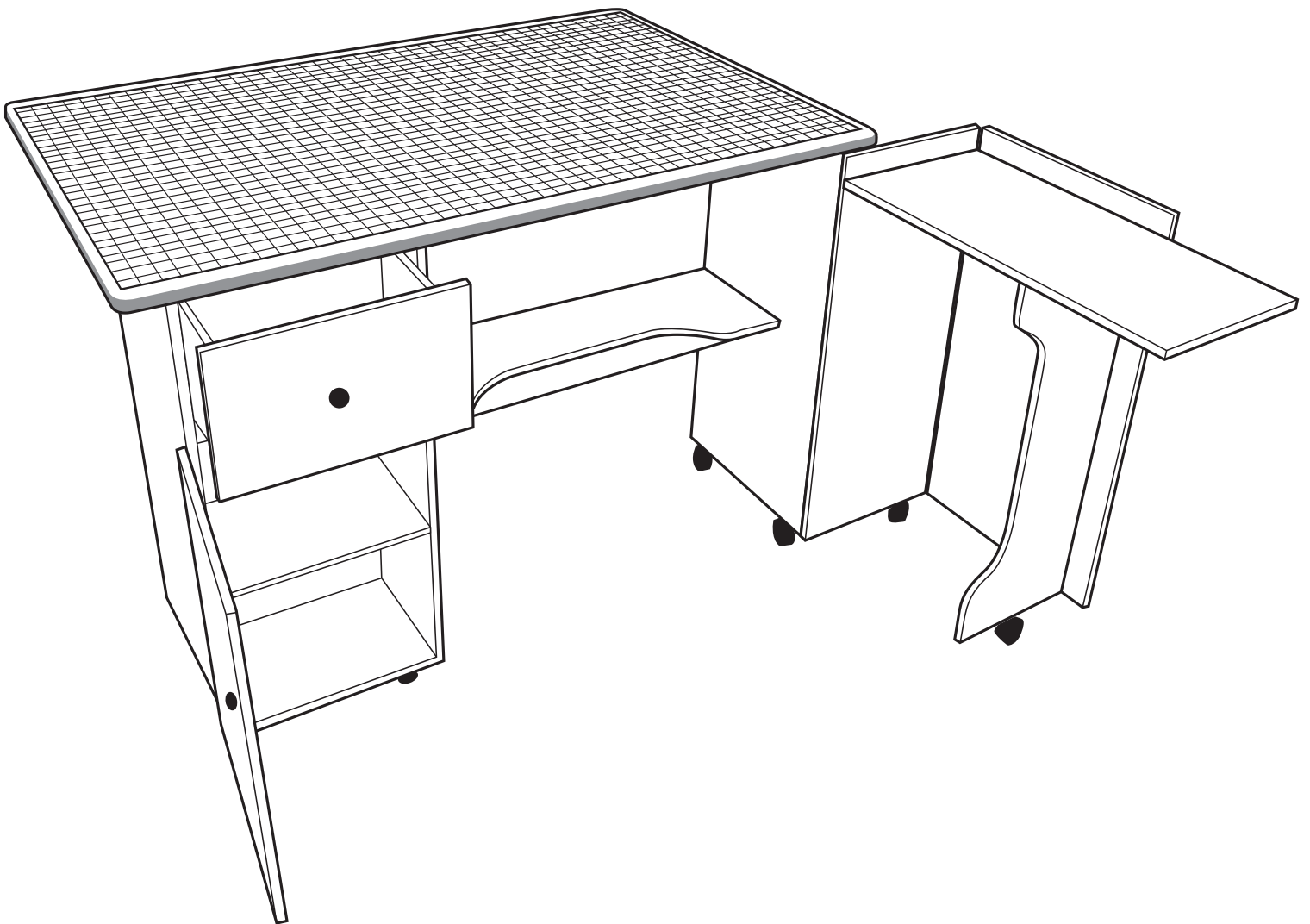

[www.SullivansUSA.net](http://www.SullivansUSA.net)

# Quilter's Table Parts List 1



**Tools Needed:**  
Phillips Head Screwdriver

**Assembly time:**  
Aprox. 50 minutes

**1. SCREWS**  
3 x 10mm  
98 pcs.



**2. SCREWS**  
3 x 12mm  
12 pcs.

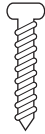

**3. SCREWS**  
5 x 50mm  
8 pcs.



**4. SCREWS**  
6 x 10mm  
16 pcs.



**5. SCREWS**  
5 x 14mm  
5 pcs.



**6. HINGES**  
5 pcs.

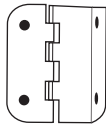

**7. HINGES**  
6 pcs.

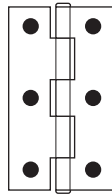

**8. HINGES**  
4 pcs.

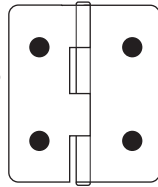

**9. LOCKING CASTER**  
2 pcs.



**10. CASTER**  
3 pcs.



**11. CASTER**  
2 pcs.



**12. CAM-BOLT**  
31 pcs.



**13. CAM-LOCK**  
31 pcs.



**14. HANDLE**  
3 pcs.

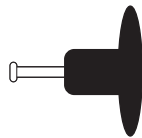

**15. PLUGS**  
2 pcs.



**16. PLUGS**  
8 pcs.



**17. METAL COVER**  
4 pcs.



**18. MAGNET**  
6 pcs.



**19. LOCKING CASTER**  
3 pcs.



**20. SLIDERS**  
2 pcs.

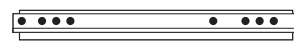

**21. OPEN END WRENCH**  
1 pc.

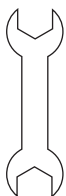

**22. ALLEN KEY**  
1 pc.



# Quilter's Table Parts List 2



**Tools Needed:**  
Phillips Head Screwdriver

**Assembly time:**  
Aprox. 50 minutes

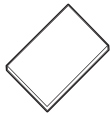

**A. PARTITION PANEL**  
12 $\frac{3}{4}$ " x 8 $\frac{3}{4}$ "  
1 pc.

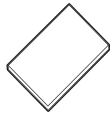

**B. PARTITION PANEL**  
12 $\frac{3}{4}$ " x 8 $\frac{3}{4}$ "  
1 pc.

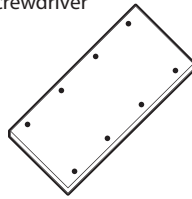

**C. BACK PANEL**  
26 $\frac{1}{4}$ " x 12 $\frac{3}{4}$ "  
1 pc.

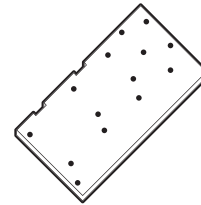

**D. LEFT PANEL**  
26 $\frac{1}{4}$ " x 14"  
1 pc.

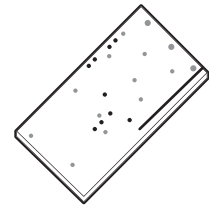

**E. RIGHT PANEL**  
26 $\frac{1}{4}$ " x 14"  
1 pc.

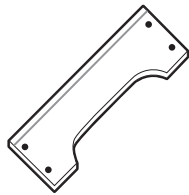

**F. CONNECTION PANEL**  
27 $\frac{1}{2}$ " x 9 $\frac{3}{4}$ "  
1 pc.

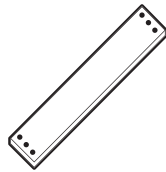

**G. CONNECTION PANEL**  
27 $\frac{1}{2}$ " x 5 $\frac{1}{8}$ "  
1 pc.

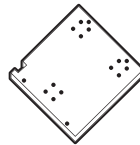

**H. BOTTOM PANEL**  
14" x 13 $\frac{3}{4}$ "  
1 pc.

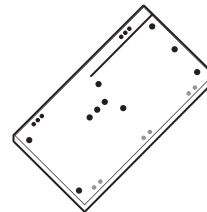

**I. RIGHT SIDE PAEL**  
26 $\frac{3}{4}$ " x 14 $\frac{1}{2}$ "  
1 pc.

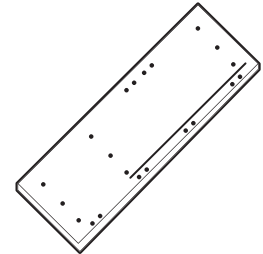

**J. TOP TABLE**  
47" x 15 $\frac{3}{4}$ "  
1 pc.

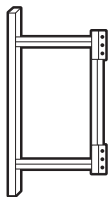

**K1. SUPPORT PANEL**  
27 $\frac{1}{8}$ " x 12 $\frac{1}{2}$ "  
1 pc.

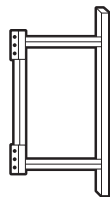

**K2. SUPPORT PANEL**  
27 $\frac{1}{8}$ " x 12 $\frac{1}{2}$ "  
1 pc.

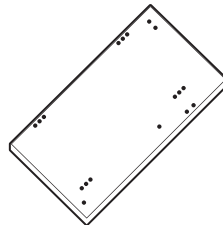

**L. RIGHT DOOR PANEL**  
26 $\frac{1}{2}$ " x 15 $\frac{3}{4}$ "  
1 pc.

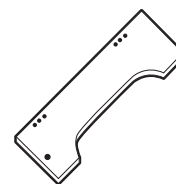

**M. SUPPORT PANEL**  
24 $\frac{3}{4}$ " x 10 $\frac{1}{8}$ "  
1 pc.

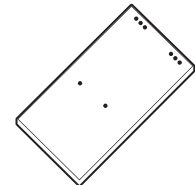

**N. TOP PANEL (TABLE SIDE)**  
23 $\frac{1}{2}$ " x 11 $\frac{3}{4}$ "  
1 pc.

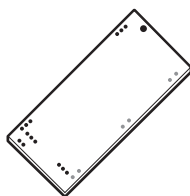

**O. RIGHT DOOR PANEL**  
26 $\frac{1}{2}$ " x 11 $\frac{3}{4}$ "  
1 pc.

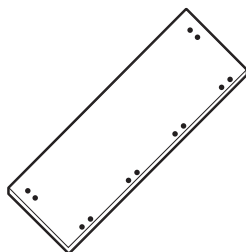

**P. TOP TABLE**  
47" x 15 $\frac{3}{4}$ "  
1 pc.



**Q. SIDE DRAWER PANEL**  
8 $\frac{1}{4}$ " x 6"  
1 pc.



**R. SIDE DRAWER PANEL**  
8 $\frac{1}{4}$ " x 6"  
1 pc.



**S. DRAWER BACK PANEL**  
12" x 6"  
1 pc.

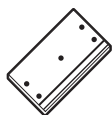

**T. DRAWER FRONT PANEL**  
13 $\frac{3}{4}$ " x 7 $\frac{3}{4}$ "  
1 pc.



**U. DRAWER BOTTOM PANEL**  
11 $\frac{1}{4}$ " x 8 $\frac{3}{4}$ "  
1 pc.

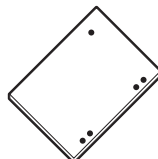

**V. LEFT DOOR PANEL**  
18 $\frac{3}{4}$ " x 13 $\frac{3}{4}$ "  
1 pc.



**W. BACK PANEL**  
30" x 13 $\frac{1}{4}$ "  
1 pc.

**Step 1**

**Step 1.** Attach all the components into the boards as per the pictures

**a) Top Panels P & J**

- Parts Required  
 1 - J TOP TABLE  
 1 - P TOP TABLE  
 8 - #2 SCREWS  
 16 - #4 SCREWS  
 4 - #8 HINGES  
 9 - #12 CAM-BOLT  
 4 - #18 MAGNET

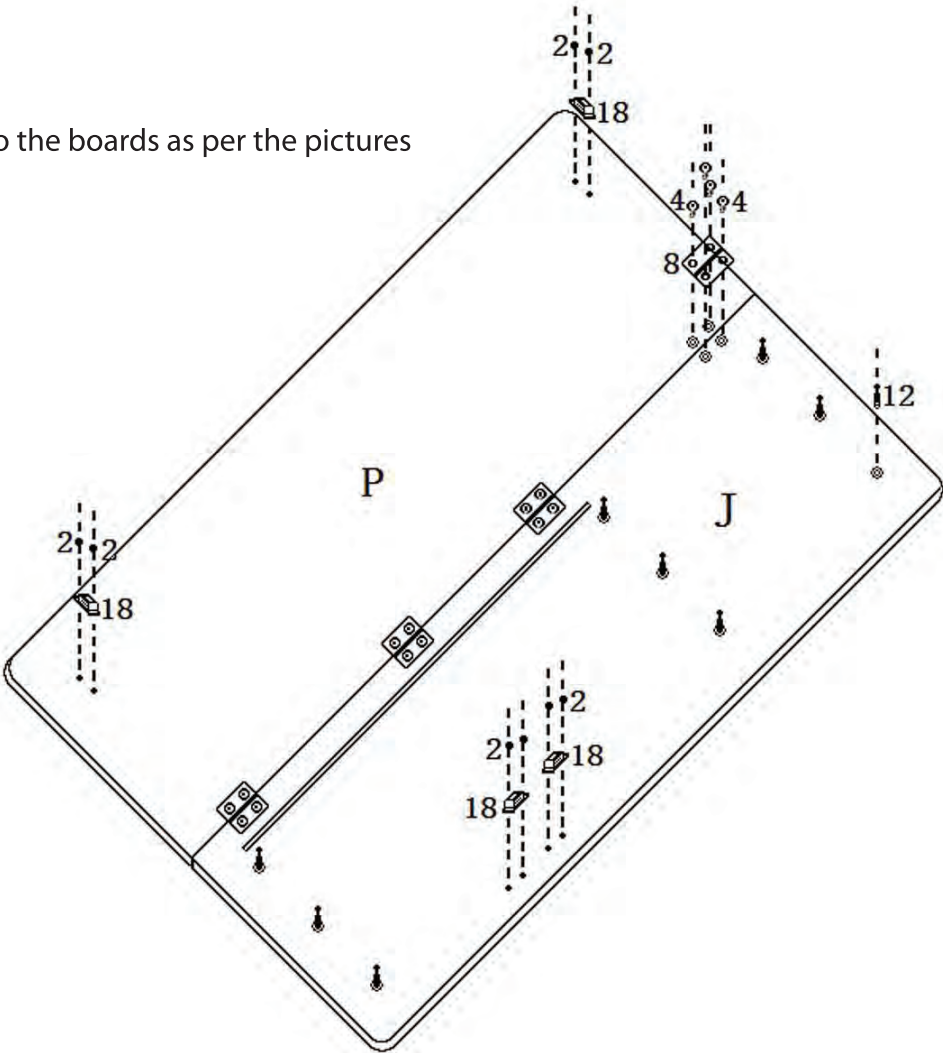

**NOTE: DO NOT TAKE #20 SLIDERS APART**

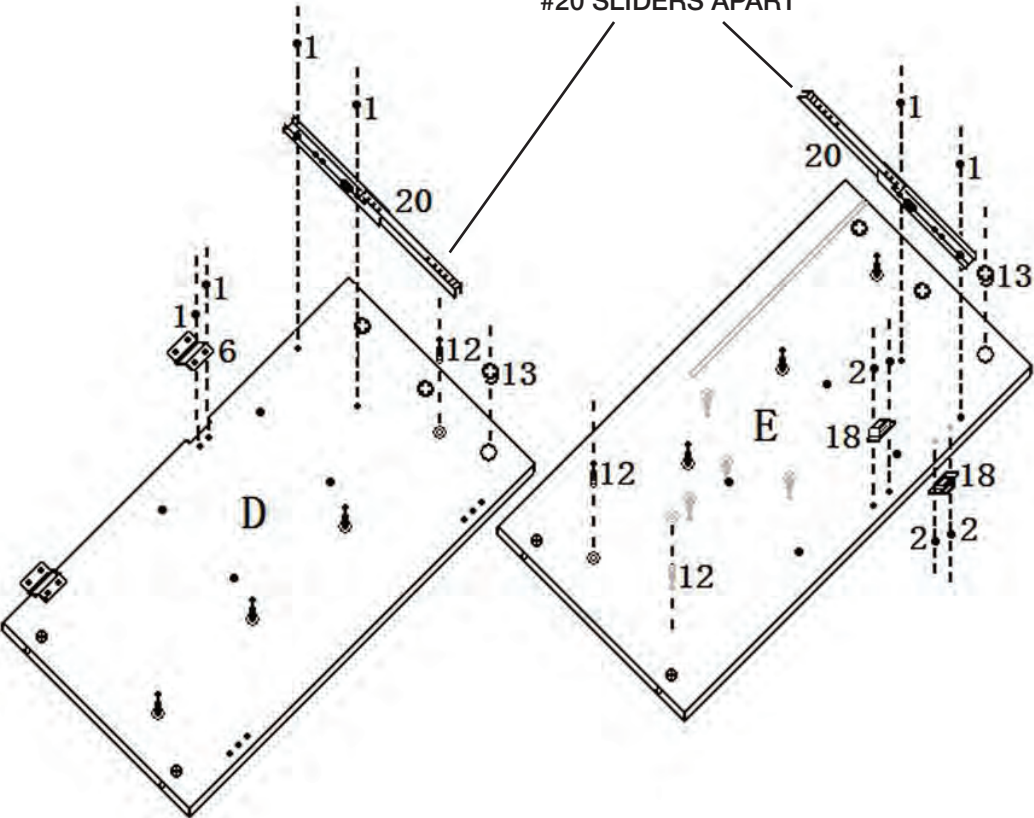

**b) Side Panels D & E**

- Parts Required  
 1 - D LEFT PANEL  
 1 - E RIGHT PANEL  
 8 - #1 SCREWS  
 4 - #2 SCREWS  
 2 - #6 HINGES  
 13 - #12 CAM-BOLT  
 6 - #13 CAM-LOCK  
 2 - #18 MAGNET  
 2 - #20 SLIDERS

**c) Right Side Doors/Panels I, O & L**

Parts Required

- 1 - I RIGHT SIDE PANEL
- 1 - L RIGHT DOOR PANEL
- 1 - O RIGHT DOOR PANEL
- 12 - #1 SCREWS
- 3 - #6 HINGES
- 5 - #12 CAM-BOLT
- 3 - #13 CAM-LOCK
- 3 - #17 METAL COVER

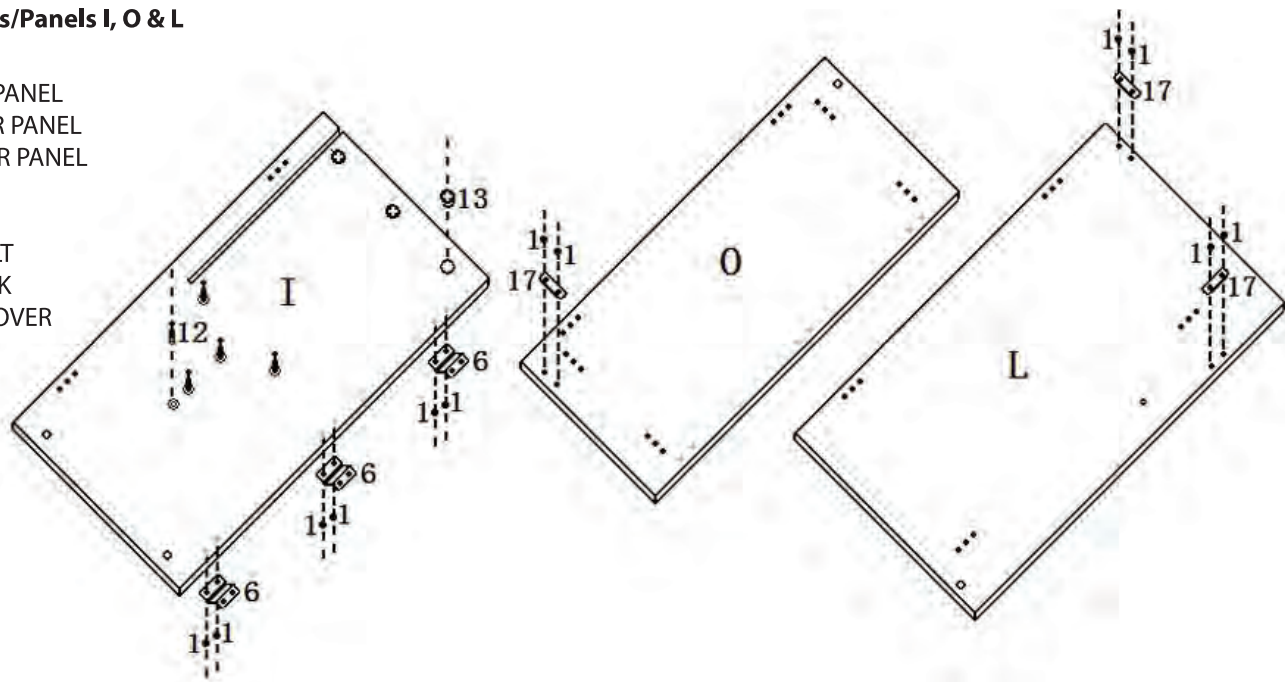

**d) Supporting Panels**

Parts Required

- |                              |                          |
|------------------------------|--------------------------|
| 1 - A PARTITION PANEL        | 1 - Q SIDE DRAWER PANEL  |
| 1 - B PARTITION PANEL        | 1 - R SIDE DRAWER PANEL  |
| 1 - C BACK PANEL             | 1 - S DRAWER BACK PANEL  |
| 1 - F CONNECTION PANEL       | 1 - T DRAWER FRONT PANEL |
| 1 - G CONNECTION PANEL       | 4 - 12 CAM-BOLT          |
| 1 - H BOTTOM PANEL           | 22 - 13 CAM-LOCK         |
| 1 - M SUPPORT PANEL          | 2 - 15 PLUGS             |
| 1 - N TOP PANEL (TABLE SIDE) | 4 - 16 PLUGS             |

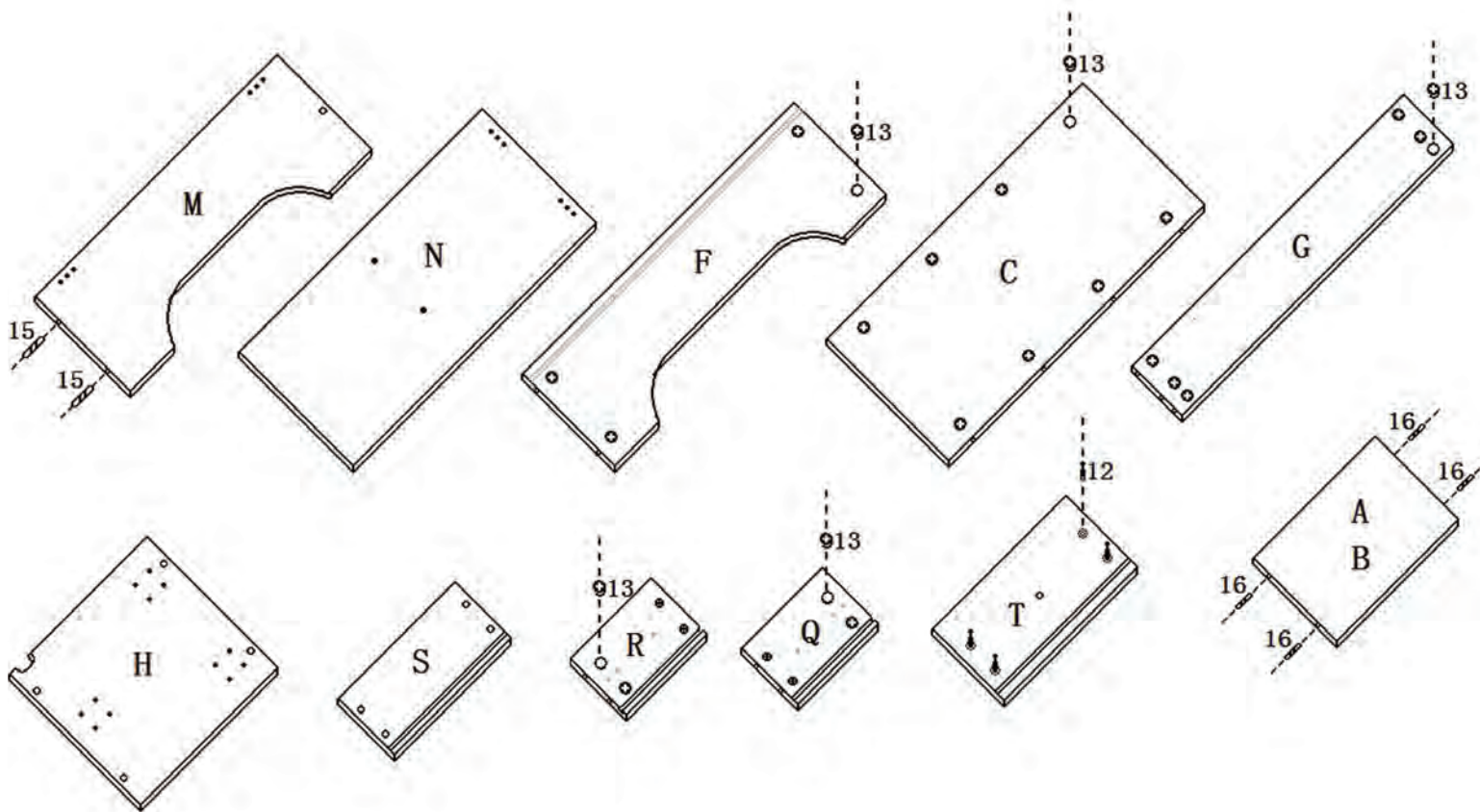



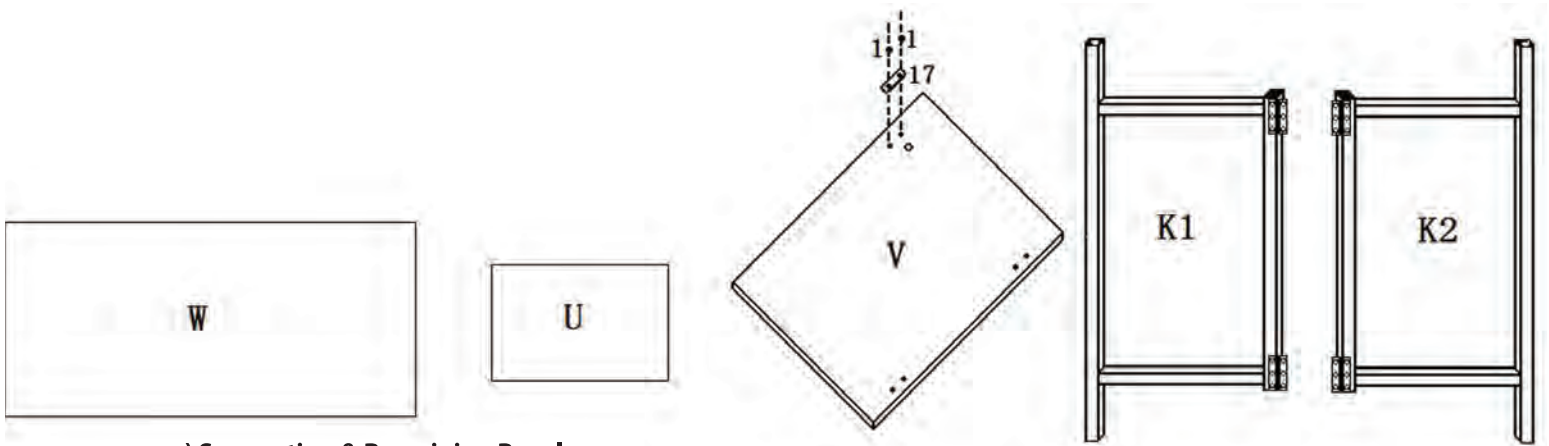

**e) Supporting & Remaining Panels**

Parts Required

- 1 - U DRAWER BOTTOM PANEL
- 1 - V LEFT DOOR PANEL
- 1 - W BACK PANEL
- 1 - K1 SUPPORT PANEL
- 1 - K2 SUPPORT PANEL
- 2 - #1 SCREWS
- 1 - #17 METAL COVER

**Step 2**

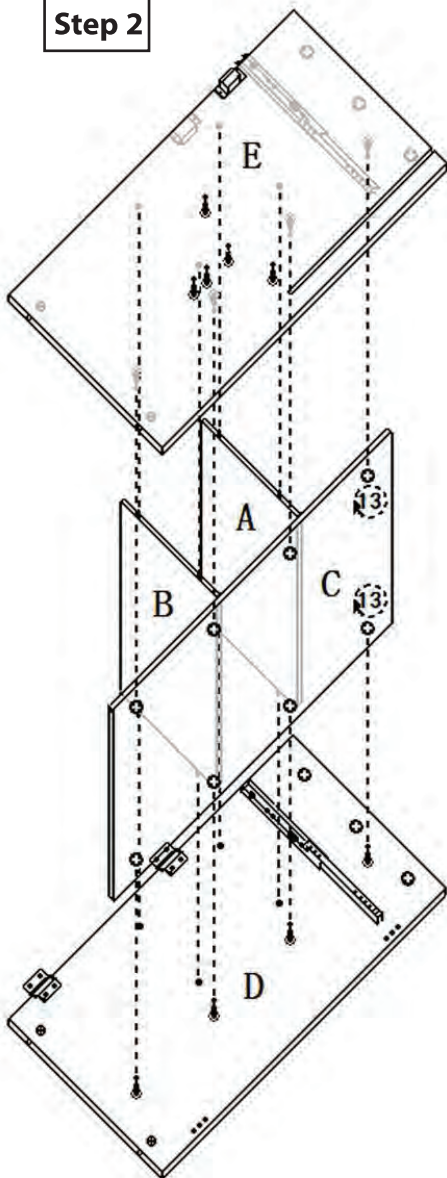

**Step 3**

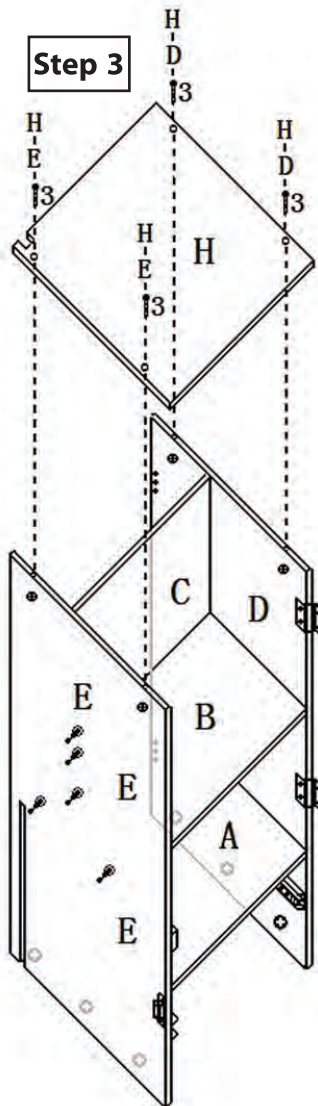

**Step 2.** To connect Back Panel (C), Partion Panel (B) and Partion Panel (A) to Left Panel (D), twist in a clockwise direction the #13 Cam-Lock located on Back Panel (C).

Then connect Right Panel(E) to Partion Panel (B), Partion Panel (A) and Back Panel (C), twist in clockwise the other #13 Cam-Lock located on Back Panel (C).

**Step 3.** Use #3 Screws to connect Bottom Panel (H) with Left Panel (D) and Right Panel (E).

Parts Required

- 4 - #3 SCREW

**Step 4**

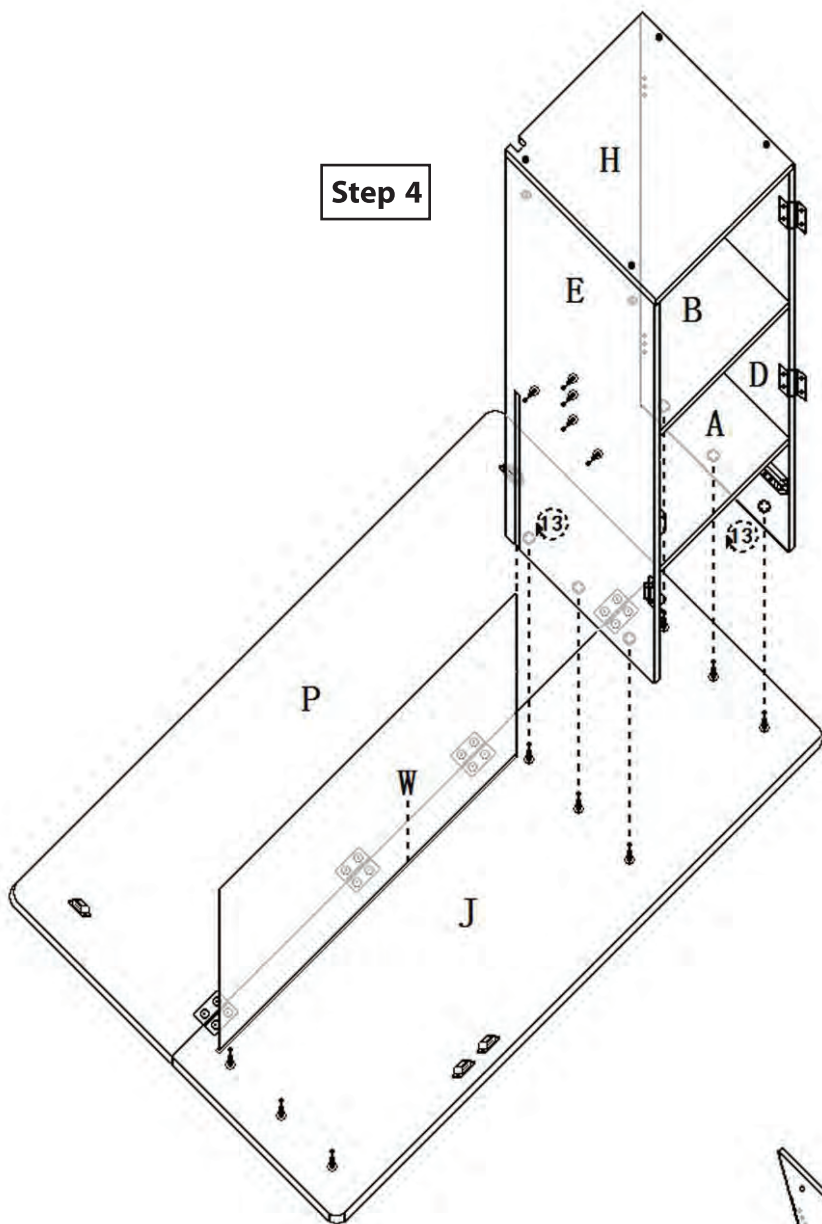

**Step 4.** Connect Left Panel (D) and Right Panel (E) with Top Table (J) by twisting clockwise the #13 Cam-Locks on the Left Panel (D) and Right Panel (E).

Insert Back Panel (W) in the groove of Top Table (J) and Right Panel (E).

**Step 5.** Attach the two Connection Panels (G & F) to the Right Panel (E) by twisting clockwise the #13 Cam-Locks on the two Connection Panels (G & F).

**Step 5**

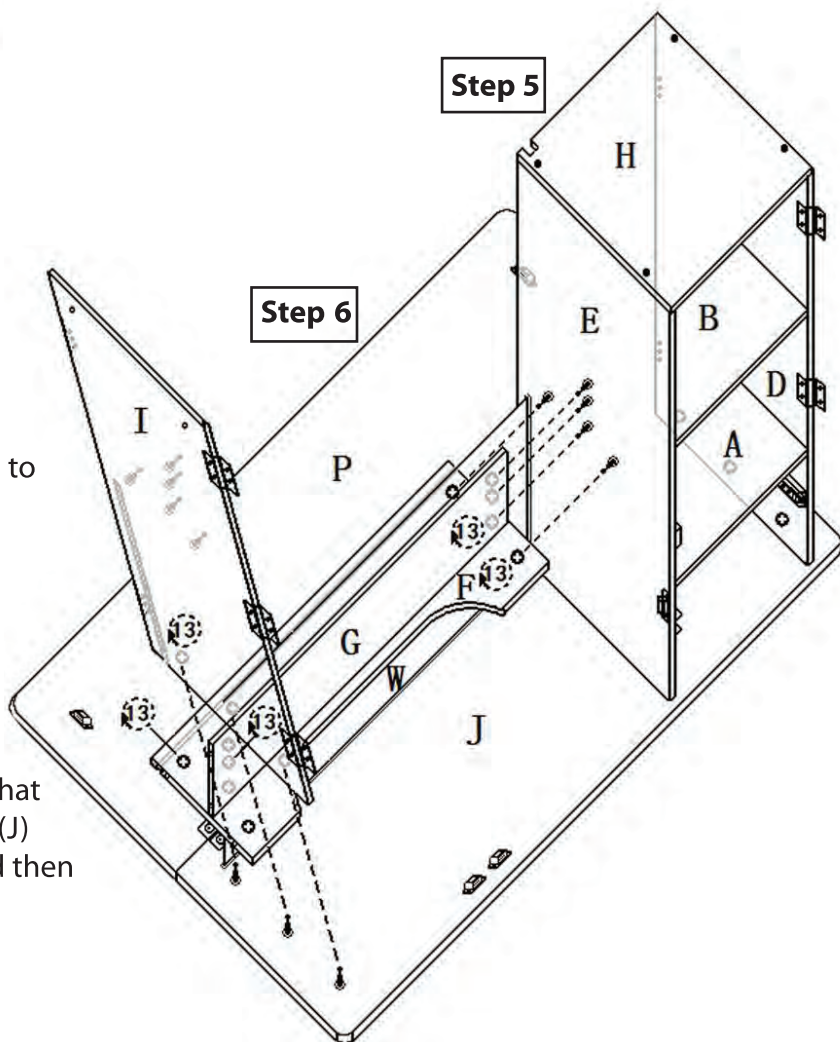

**Step 6**

**Step 6.** Tilt-insert Right Side Panel (I) that has #13 Cam-Locks with the Top Table (J) and two Connection Panels (G & F) and then fasten the #13 Cam-Locks clockwise.

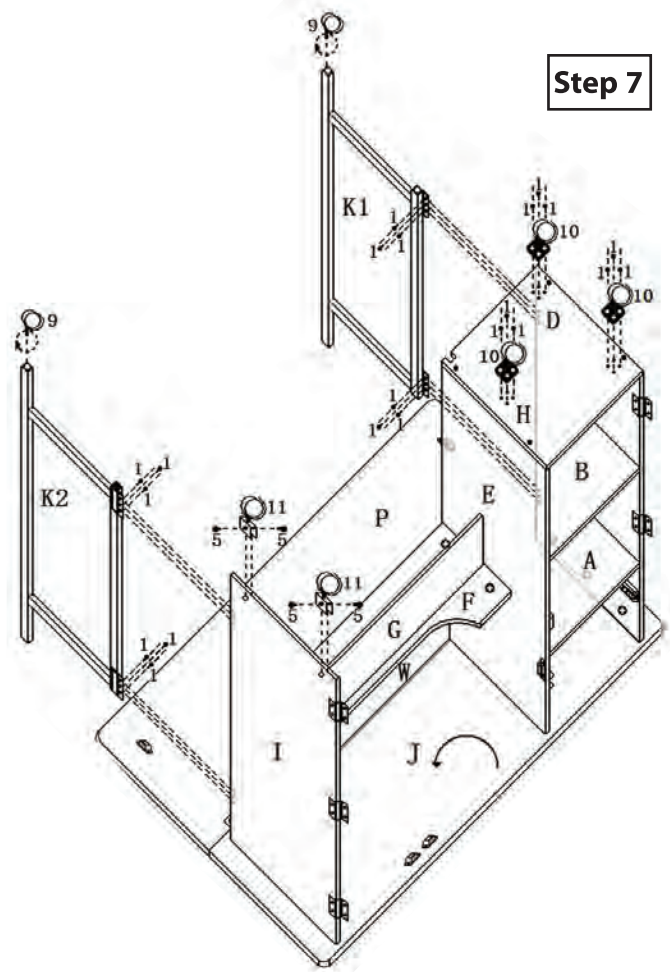

**Step 7**

**Step 7.**

Use #1 Screws to fasten the two square shaped Support Panels (K1 & K2) onto Left Panel (D) and Right Side Panel (I).

Install the #9 Locking Casters onto the two square shaped Support Panels (K1 & K2).

Use #1 Screws to install #10 Casters onto Bottom Panel (H).

Use #5 Screws to install #11 Casters onto Right Side Panel (I).

Parts Required

- 24 - #1 SCREWS
- 2 - #5 SCREWS
- 2 - #9 LOCKING CASTERS
- 3 - #10 CASTERS
- 2 - #11 CASTERS

**Step 8.**

Use #5 Screws to install the #19 Locking Casters onto the Right Door Panel (O), Right Door Panel (L) and Support Panel (M).

Use #1 Screws and #7 Hinges to join Right Door Panel (O) and Right Door Panel (L).

Use #1 Screws and #7 Hinges to join Support Panel (M) and Right Door Panel (L).

Use #1 Screws and #7 Hinges to join Top Panel - Table Side (N) and Right Door Panel (O).

Parts Required:

- 36 - #1 SCREWS
- 3 - #5 SCREWS
- 6 - #7 HINGES
- 3 - #19 LOCKING CASTERS

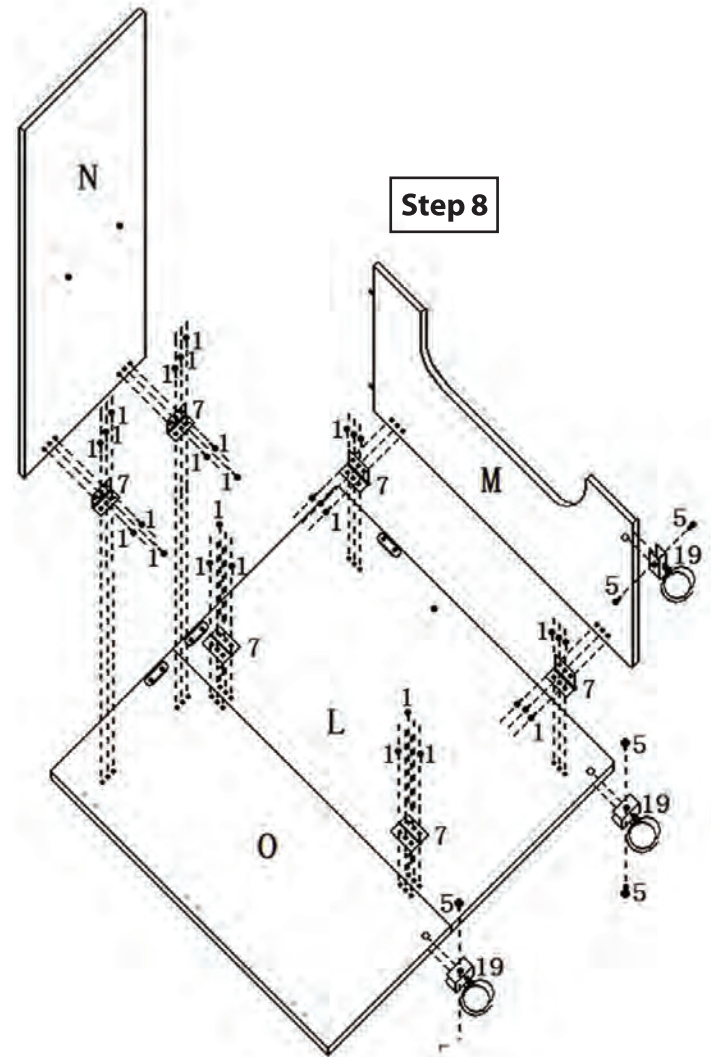

**Step 8**



**Step 9**

**Step 9.**

Connect the two Side Drawer Panels (Q & R) with the Drawer Front Panel (T) by twisting in a clockwise direction the #13 Cam-Locks that are located on the two Side Drawer Panels (Q & R).

Slide the Drawer Bottom Panel (U) into the grooves of the two Side Drawers (Q & R) and Drawer Front (T) Panels.

Use #3 Screws to attach Drawer Back Panel (S) on to the two Side Drawer Panels (Q & R).

Parts Required 4 - #3 SCREWS

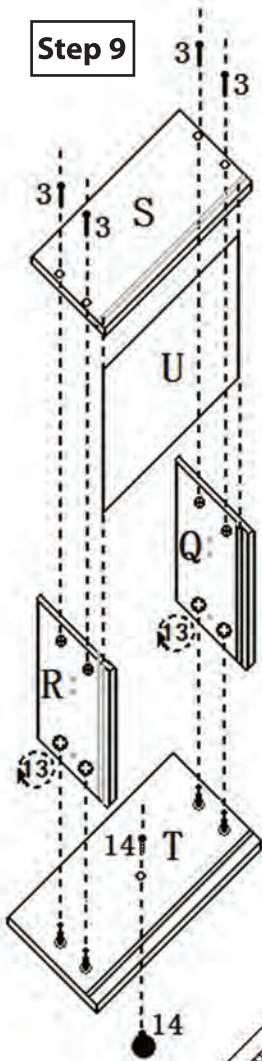

**Step 10.**

Use #1 Screws to attach #20 Sliders to both Side Drawer Panels (Q & R).

Parts Required 6 - #1 SCREWS

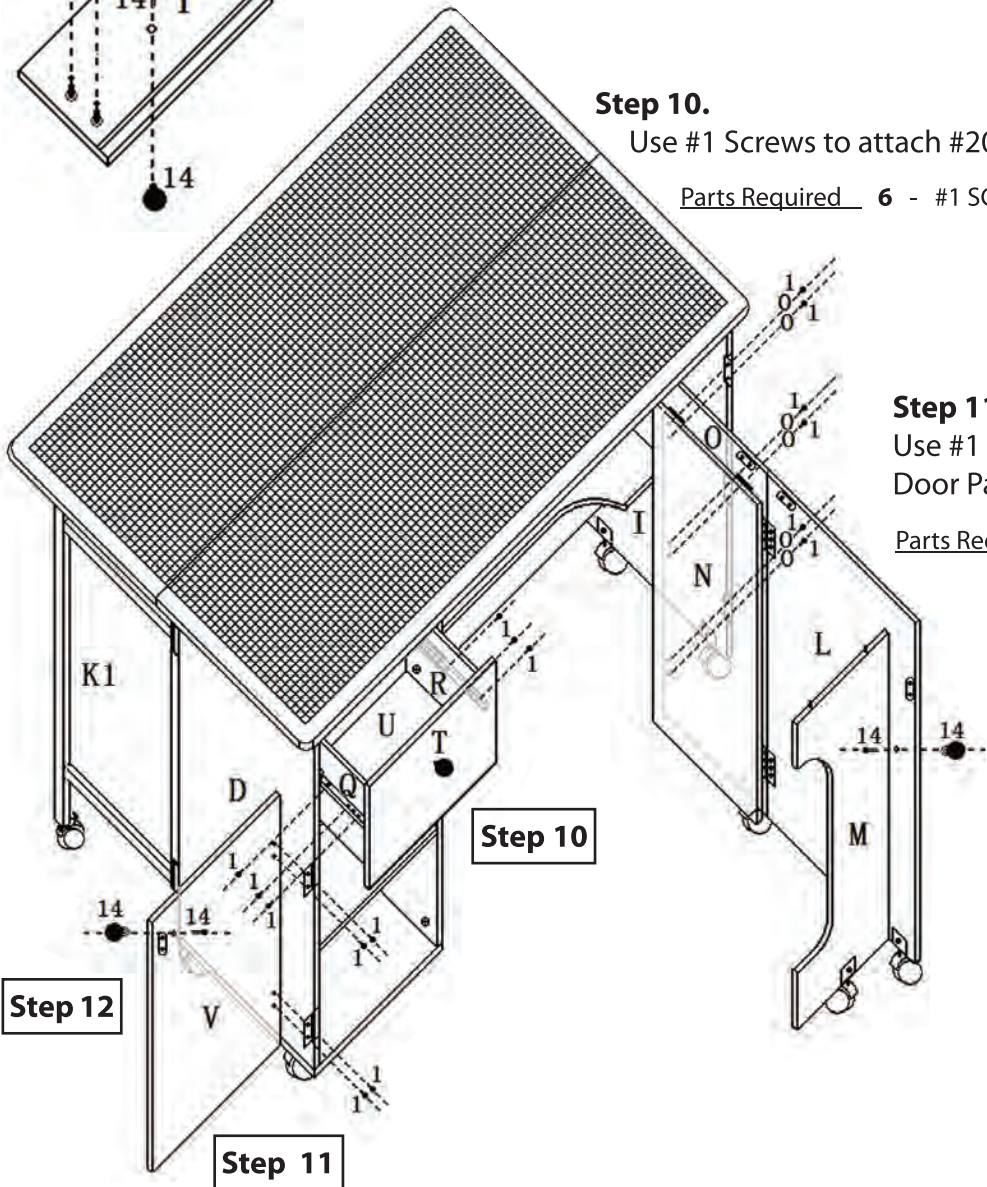

**Step 11.**

Use #1 Screws to attach both the Left and Right Door Panels (V & O) to the #6 Hinges.

Parts Required 10 - #1 SCREWS / VIS

**Step 12.**

Install #14 Handles onto the Drawer Front Panel (T), Left Door Panel (V) and Right Door Panel (L).

Parts Required 3 - #14 HANDLES

**Step 12**

**Step 11**

**Step 10**

## **Safety & Maintenance**

This table is not a toy - do not let children play on, under, or around it. Do not place more than 30 pounds on the table wings. To clean the table, use a cloth or sponge with mild soap (never use anything abrasive). Never rest a hot iron directly on the surface.

For ironing, use the Home Hobby Table Ironing Cover - in stores everywhere.



### **Sullivans USA**

4341 Middaugh Avenue, Downers Grove, IL 60515

Toll Free: (800) 862-8586

Fax: (630) 435-1532

### **M.T. Sullivans & Co. Pty. Ltd.**

40 Parramatta Road, Underwood, Brisbane, Queensland Australia

### **Sullivans Enterprises (N.Z.) Ltd.**

28 Sir William Avenue, East Tamaki, Auckland New Zealand

**Sullivans USA Inc.** Will replace any missing or defective parts within 30 days of purchase. Please Fax a dated receipt with your request to (630) 435-1532 or send an e-mail to [sulnotions@sbcglobal.net](mailto:sulnotions@sbcglobal.net)

### **This policy does not apply to damages due to shipping**

For further assistance, please call (800) 862-8586

**PLEASE NOTE:** Our 30-day No Charge replacement policy for parts does not apply to items sold AS IS, CLEARANCE, CLOSEOUT, FINAL SALE, ETC. Any parts requested under these circumstances will be charged to the customer, including shipping charges.

Shipping charges for replacement parts to Alaska, Hawaii or any point outside of The Contiguous United States are not covered under our policy. Some restrictions apply. See website for details.



# **DO NOT RETURN TO THE STORE**

**FOR ASSISTANCE WITH MISSING OR REPLACEMENT  
PARTS, INSTALLATION, OR INFORMATION**

**PLEASE CALL US AT**

**800.862.8586**



[www.sullivansusa.net](http://www.sullivansusa.net)



[www.sullivansusa.net](http://www.sullivansusa.net)

**4341 MIDDAUGH AVENUE • DOWNERS GROVE, IL 60515 • ORDERS: 800.862.8586 • FAX: 630.435.1532**